

METALS

TRIM CATALOG

TRIM PLACEMENT PG.1

29 GA TRIM COVER PG.2

PG.3 Panel Profiles For 29 GA Profiles
PG.4 Tools & Materials Needed
PG.5 - 8 Trim Profiles

26 GA TRIM COVER PG.9

PG.10 26 Ga Panel Profile
PG.11 Tools & Materials Needed
PG.12 - 14 Trim Profiles

STANDING SEAM TRIM COVER PG.15

PG.16 Standing Seam Profiles
PG.17 Tools & Materials Needed
PG.18 - 19 Trim Profiles

BOARD & BATTEN TRIM COVER PG.20

PG.21 Standing Seam Profiles
PG.22 Tools & Materials Needed
PG.23 - 24 Trim Profiles

HOW TO ORDER CUSTOM TRIM PG.25

METAL COLOR

PG.26-28 COLOR OPTIONS

NOTES PG.29

We understand that choosing the right materials is crucial for the success of any building endeavor. That's why we are dedicated to providing exceptional customer service and support throughout the entire process. From the initial consultation to the final installation, our knowledgeable team is here to assist you in selecting the best products for your specific needs.



Trim Placement

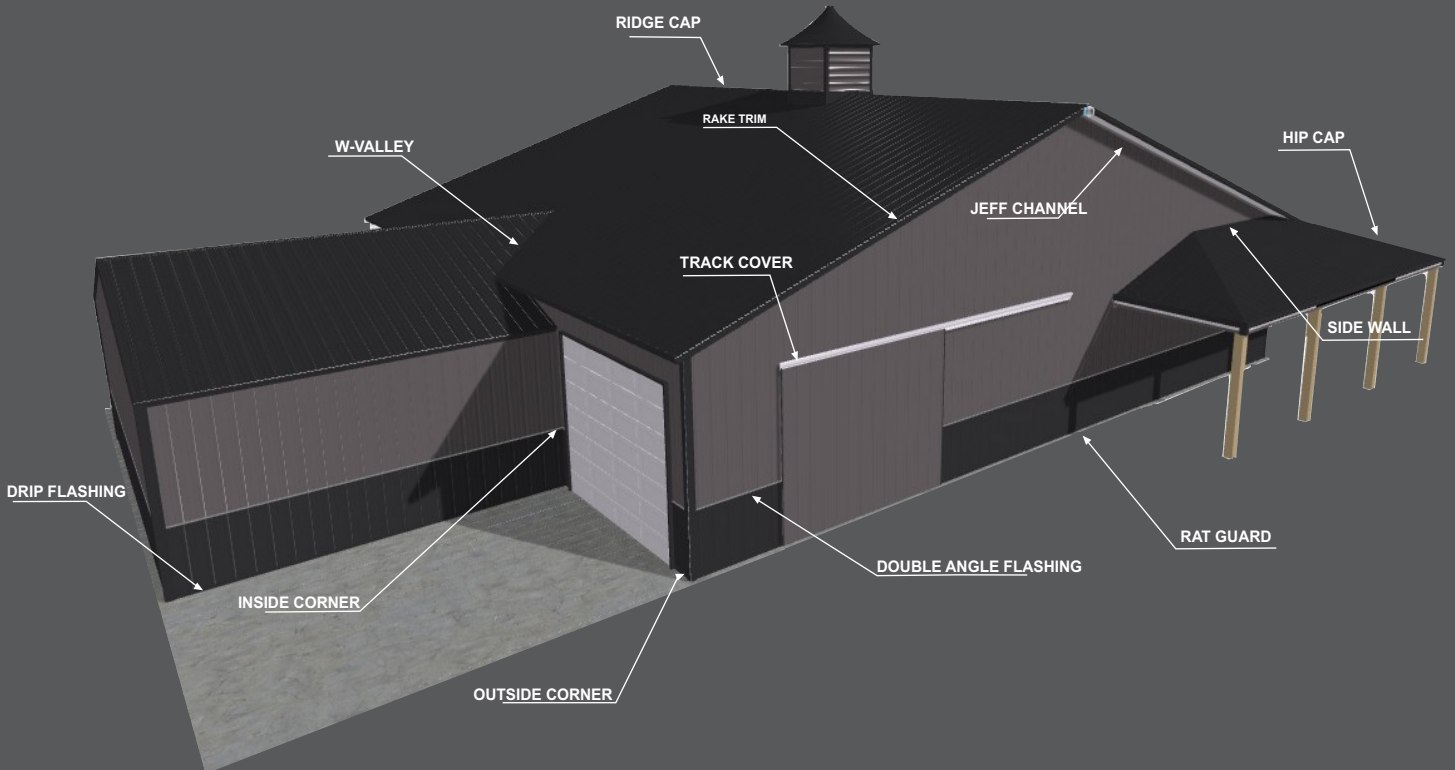
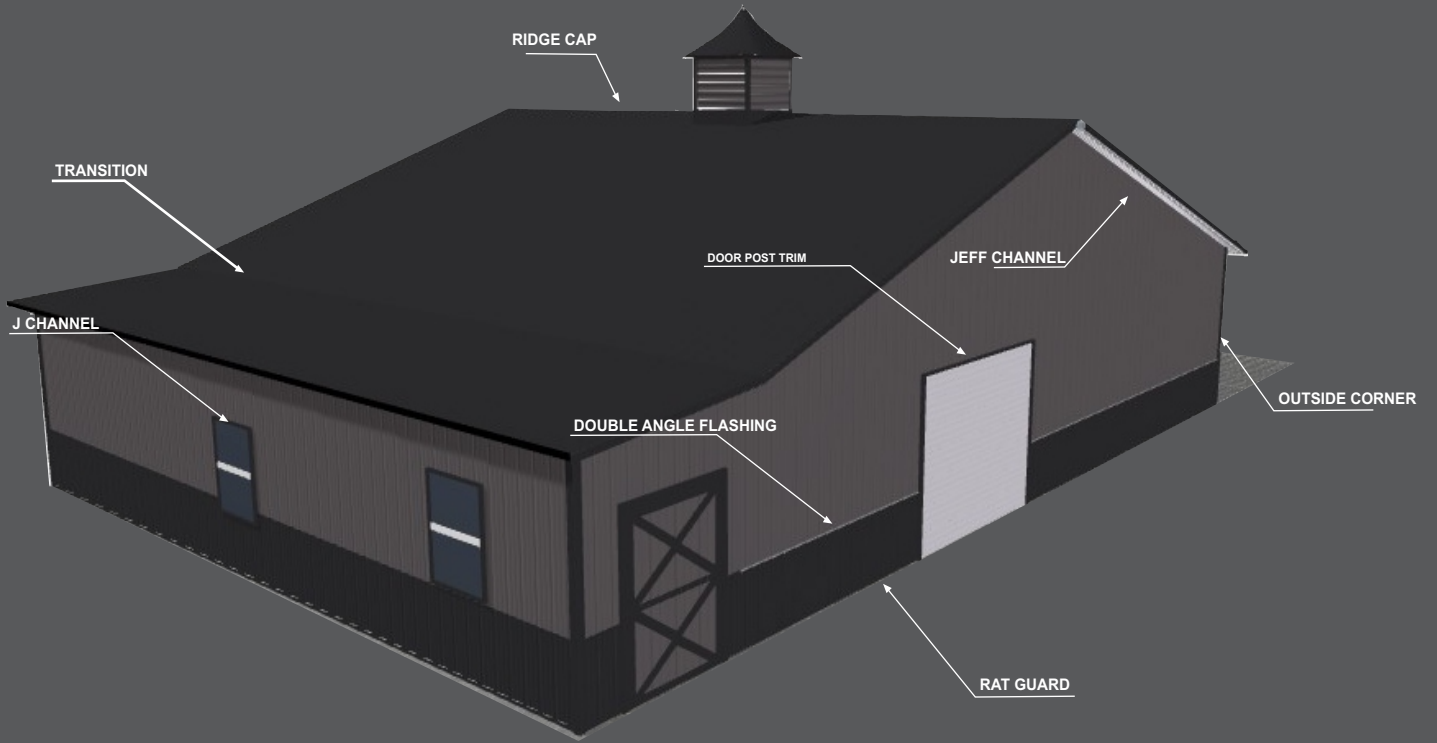

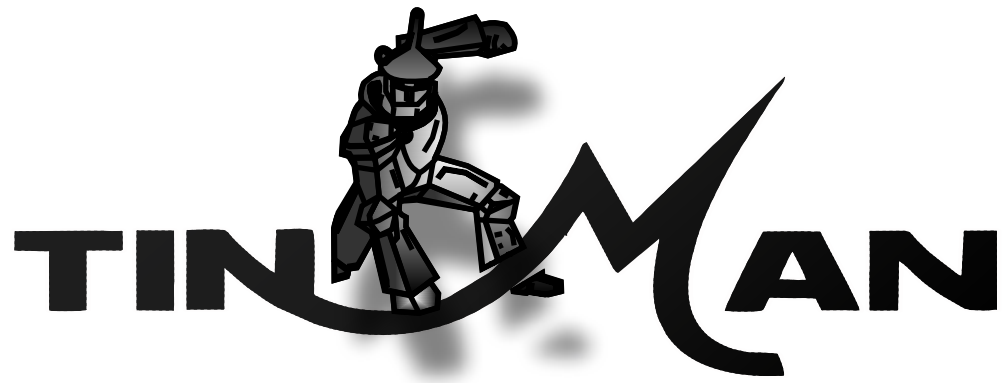

METALS

29 GAUGE

TRIM CATALOG

Tin ManRIB

Tough steel construction makes the Tin Man Rib Panel an economical yet durable metal roofing or metal siding solution for residential, industrial and commercial structures. 29 gauge and 26 gauge option.

Exposed fastener panel

Multi-purpose, which makes them great for siding too

Available in lengths of 3' through 40'

29 gauge painted Galvalume

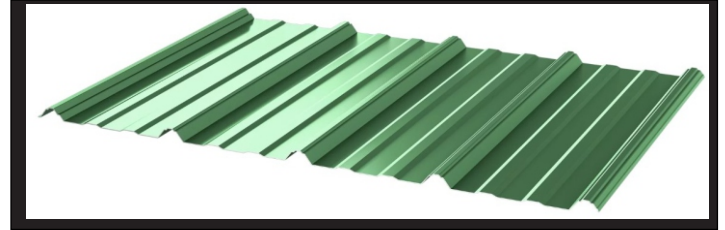

TIN MAN APEX PANEL

Tough steel construction makes the Tin Man Rib Panel an economical yet durable metal roofing or metal siding solution for residential, industrial and commercial structures. 29 gauge and 26 gauge option

3' COVERAGE

3/4" RIB

Replicates Standing Seam Half The price
Exposed Fastener

Applies Over Open Frame Solid Surface Recommended
Minimun roof 3:12

29 gauge painted Galvalume

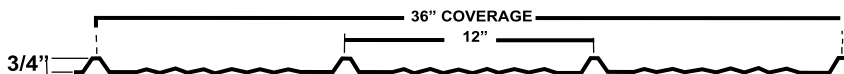
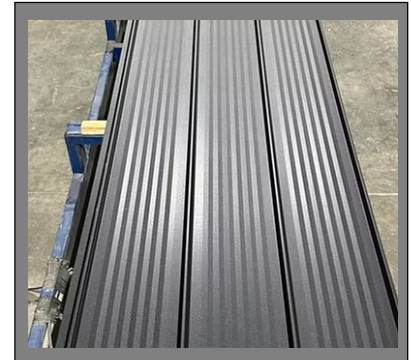

5V CRIMP METAL





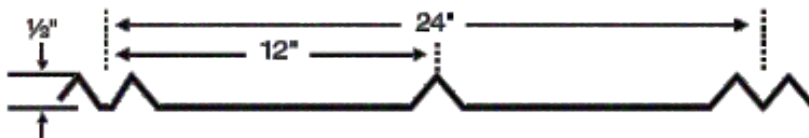
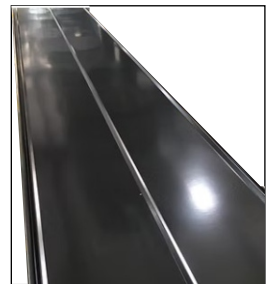

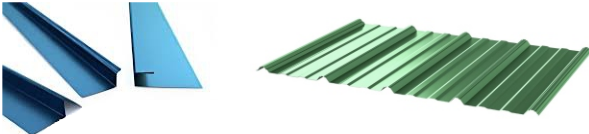

The durable 5V Crimp metal panel offers a traditional look that has become popular with customers. These panels are durable and long-lasting making them an excellent option for residential and agricultural buildings.

Applications - Roof
Coverage Width - 24"
Rib Height - 1/2"
Panel Attachment - Exposed Fastening System
Gauge - 29



Tools and Materials Needed

Before starting the installation, gather all necessary tools and materials. This ensures a smooth workflow and reduces interruptions. Essential items include:

	<p>METAL ROOFING PANELS & TRIM PIECES</p>
	<p>SAFETY HARNESS AND LADDER</p>
	<p>UNDERLAYMENT</p>
	<p>ROOFING SCREWS WITH RUBBER WASHER</p>
	<p>ROOFING NAILS</p>
	<p>METAL SNIPS OR A CUTTING TOOL</p>
	<p>MEASURING TAPE</p>
	<p>CAULKING GUN WITH METAL ROOFING SEALANT</p>
	<p>CORDLESS POWER DRILL WITH HEX HEAD FOR ROOFING SCREWS</p>

29 GAUGE TRIM CATALOG

Ridge Cap 12"

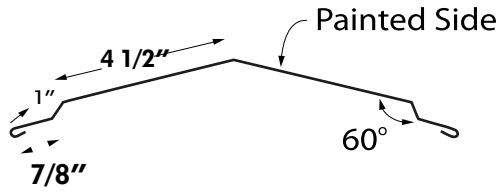

STANDARD LENGTH 10' 2"

Ridge Cap 20"

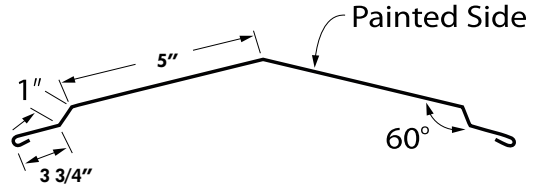

STANDARD LENGTH 10' 2"

Hip Cap 12"

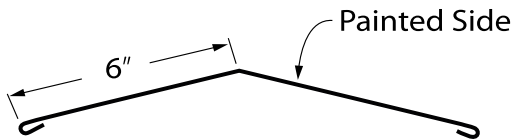

STANDARD LENGTH 10' 2"

W-Valley

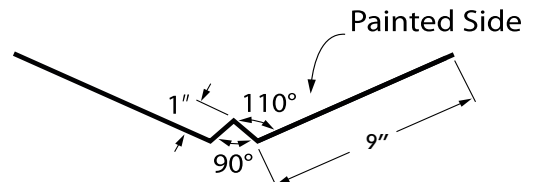

STANDARD LENGTH 10' 2"

Narrow Outside Corner

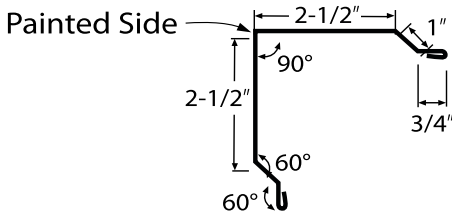

STANDARD LENGTH 10' 12' 14' 16'

Outside Corner

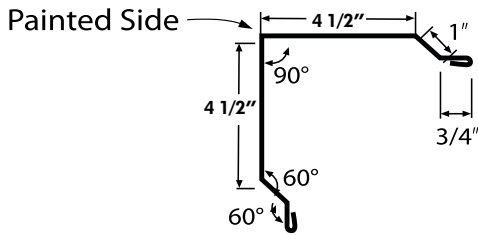

STANDARD LENGTH 10' 12' 14' 16'

Combo Corner

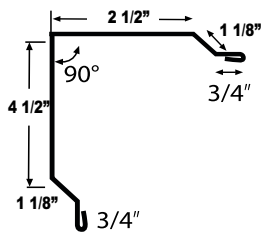

STANDARD LENGTH 10' 2"

Residential Gable/Rake

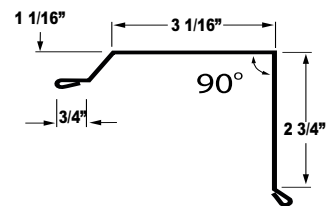

STANDARD LENGTH 10' 2"

Gable Trim

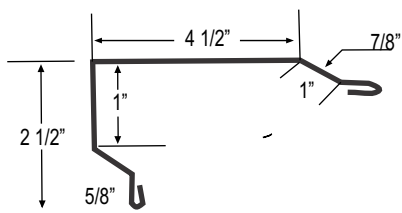

STANDARD LENGTH 10' 2"

StepRake

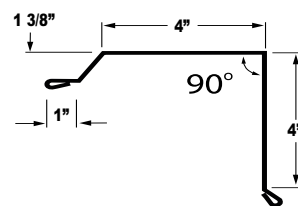

STANDARD LENGTH 10' 2"

29 GAUGE TRIM CATALOG

Side Wall Flashing

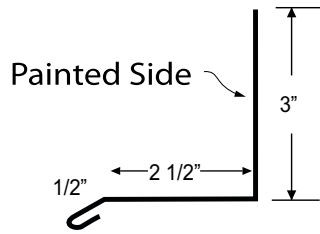

STANDARD LENGTH 10' 2"

4" Side Wall Flashing

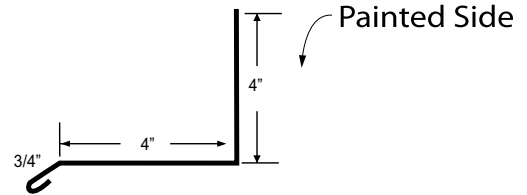

STANDARD LENGTH 10' 2"

Step Side Wall Flashing

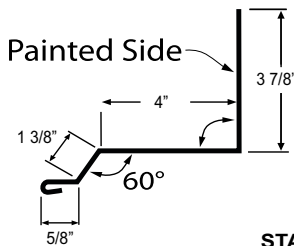

STANDARD LENGTH 10' 2"

INSIDE CORNER

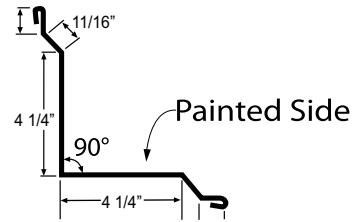

STANDARD LENGTH 10' 2"

Eave Drip 2.5

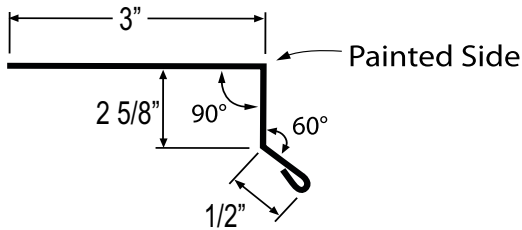

STANDARD LENGTH 10' 2"

House 1.5 Eave Drip

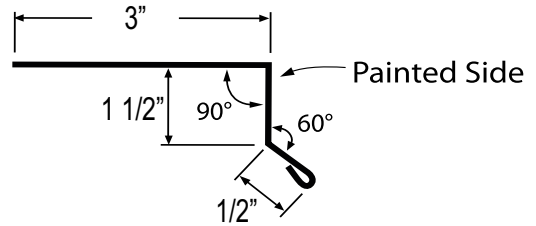

STANDARD LENGTH 10' 2"

J Channel

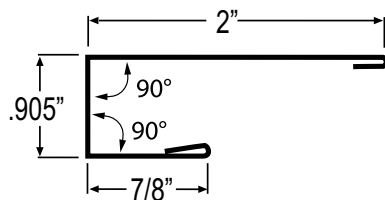

STANDARD LENGTH 10' & 12'

1.5" x 1.5" Angle

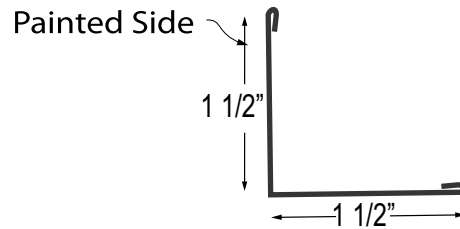

STANDARD LENGTH 10' 2"

Door Track Cover

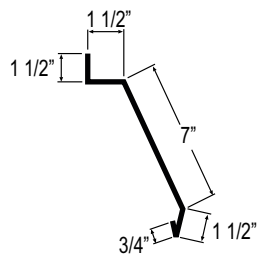

STANDARD LENGTH 10' 2"

Double Door Track Cover

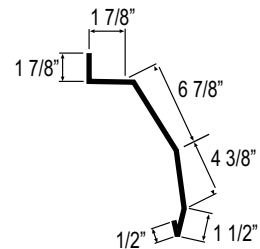

STANDARD LENGTH 10' 2"

29 GAUGE TRIM CATALOG

Drip Flashing

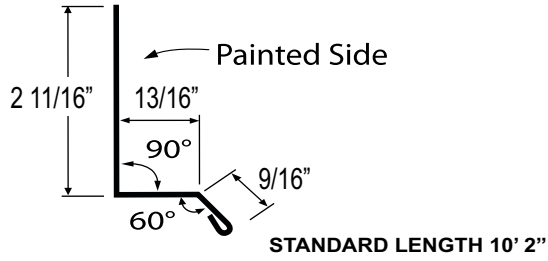

End wall Flashing

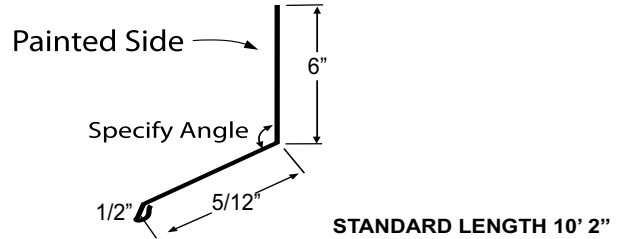

Transition Flashing

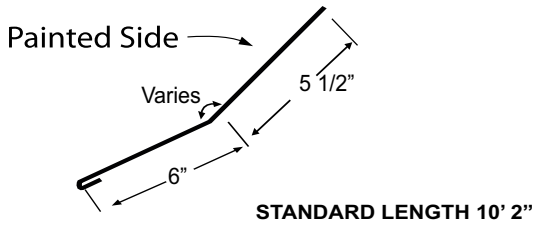

Gambrel Flashing

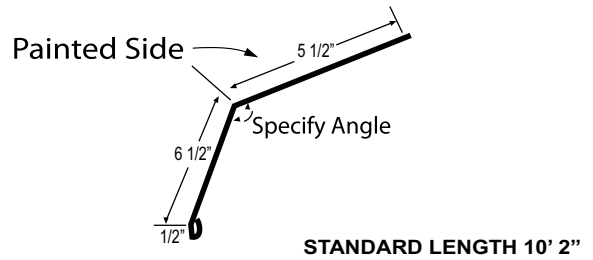

3" x 3" Angle

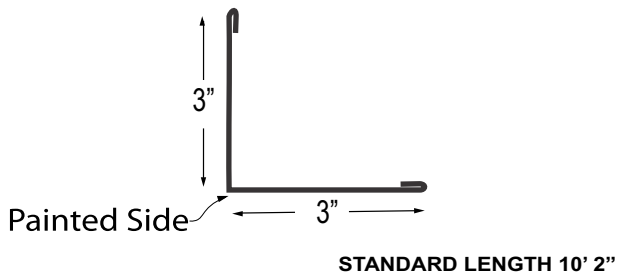

Fascia Eave Trim

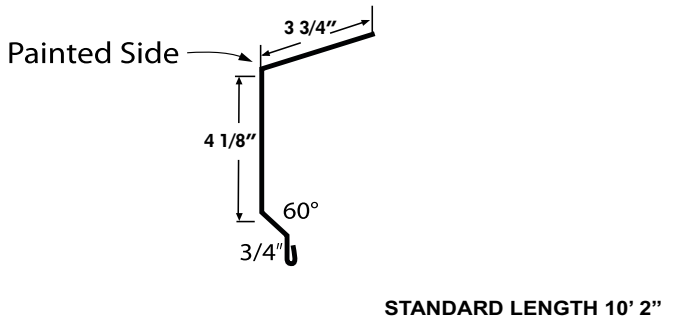

Rat Guard

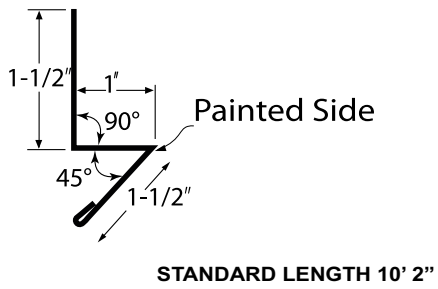

Double Angle Flashing

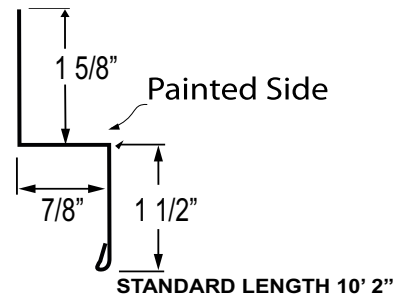

Overhead Door Trim

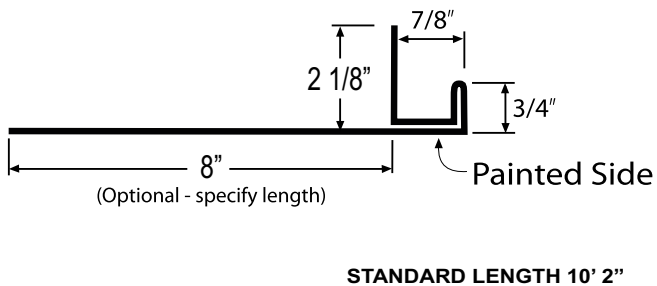

29 GAUGE TRIM CATALOG

1.5"x 3.5" / 5.5" / 7.5" Angle

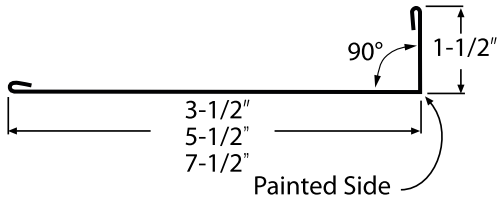

STANDARD LENGTH 10' 2"

Snow Jack

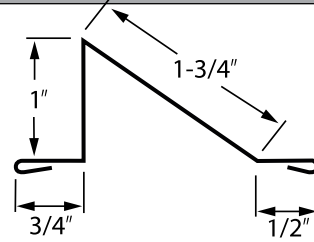

STANDARD LENGTH 10' 2"

F & J Trim

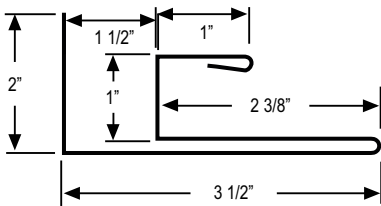

STANDARD LENGTH 10' 2"

Custom Eave Soffit

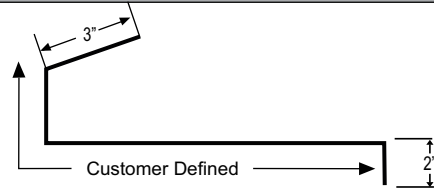

STANDARD LENGTH 10' 2"

Custom Gable Soffit

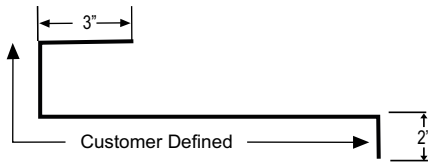

STANDARD LENGTH 10' 2"

Fascia Eave Trim

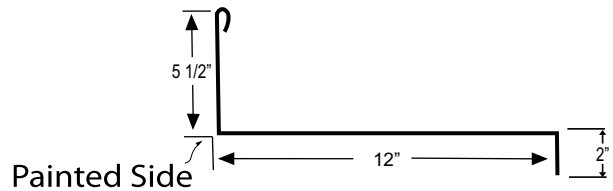

STANDARD LENGTH 10' 2"

Base Mold

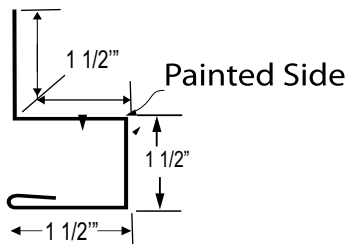

STANDARD LENGTH 10' 2"

Fascia

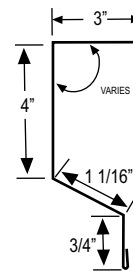

STANDARD LENGTH 10' 2"

Custom Bends Also Available

26 GAUGE HI-RIB

TRIM

26 GAUGE HI-RIB

For commercial and industrial projects, this deep rib panel is a great fit. The 26 gauge steel of the PBR panel creates a strong panel that is enhanced by a purlin bearing leg. It is available either unpainted or finished with a high-performance Enduracote paint system.

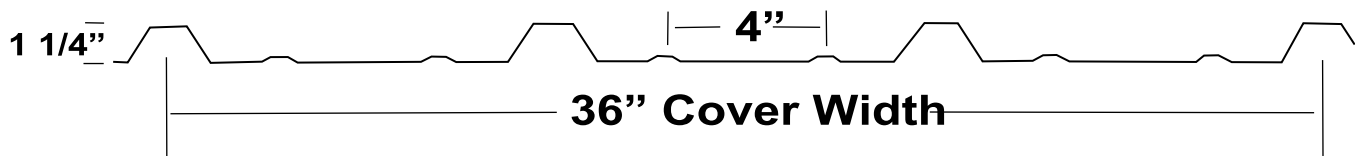

Exposed fastener system

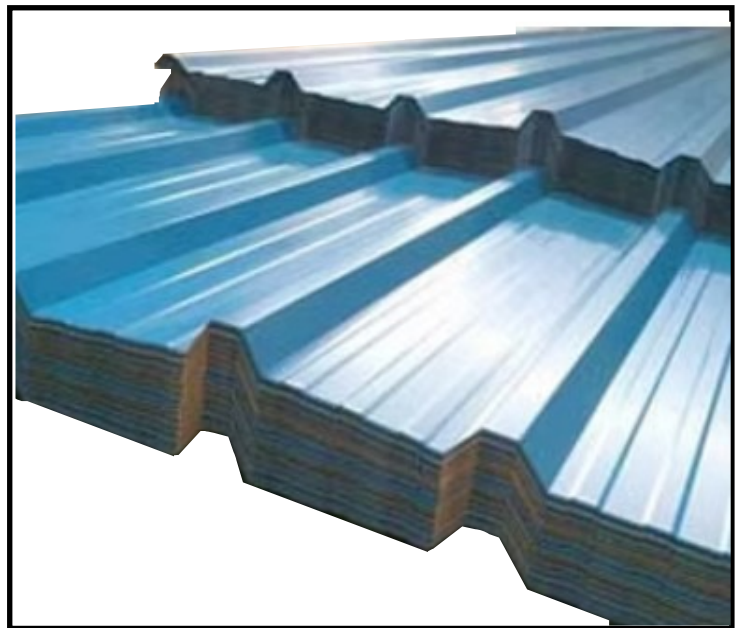

Minimum pitch recommended 1:12

26g, 1 1/4" rib height

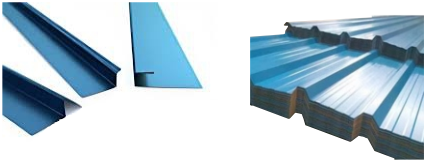

Tools and Materials Needed

Before starting the installation, gather all necessary tools and materials. This ensures a smooth workflow and reduces interruptions. Essential items include:

	METAL ROOFING PANELS & TRIM PIECES
	SAFETY HARNESS AND LADDER
	UNDERLAYMENT
	ROOFING SCREWS WITH RUBBER WASHER FOR WOOD OR STEEL
	ROOFING NAILS AND POP RIVETS
	METAL SNIPS OR A CUTTING TOOL
	MEASURING TAPE
	CAULKING GUN WITH METAL ROOFING SEALANT
	CORDLESS POWER DRILL WITH HEX HEAD FOR ROOFING SCREWS

26 GAUGE HI RIB

HI-RIB Ridge Cap

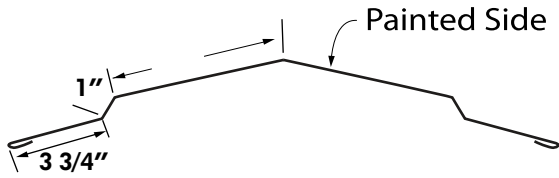

STANDARD LENGTH 10' 2"

HI-RIB CORNER

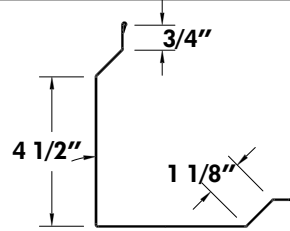

STANDARD LENGTH 10' 2"

HI-Rib Transition Flashing

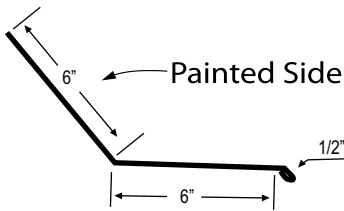

STANDARD LENGTH 10' 2"

HI-RIB Gable/Rake

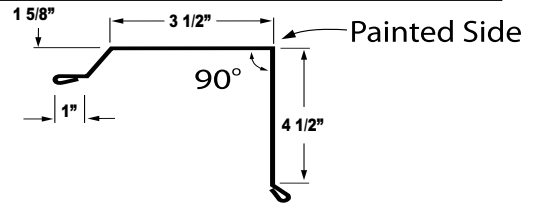

STANDARD LENGTH 10' 2"

HI-Rib W-Valley

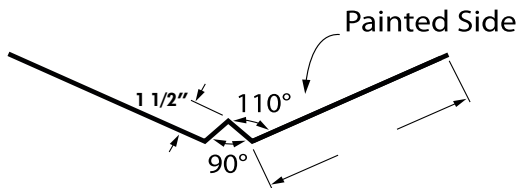

STANDARD LENGTH 10' 2"

HI-Rib Drip Edge

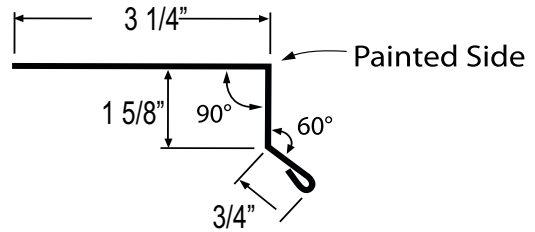

STANDARD LENGTH 10' 2"

HI-Rib Rat Guard

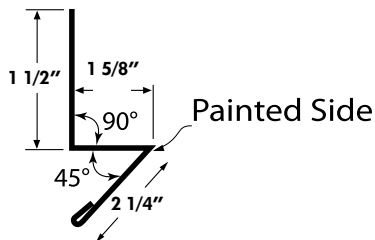

STANDARD LENGTH 10' 2"

HI-Rib Double Angle Flashing

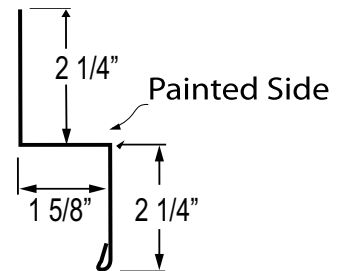

STANDARD LENGTH 10' 2"

HI-Rib Drip Flashing

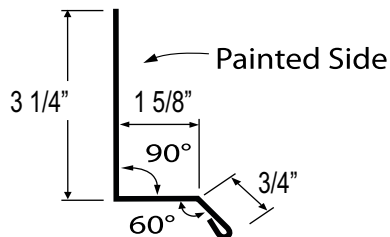

STANDARD LENGTH 10' 2"

HI-Rib Fascia Eave Trim

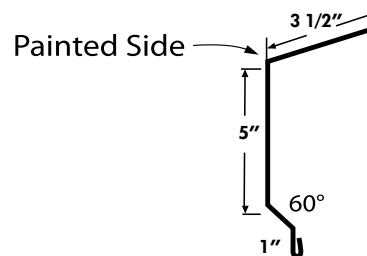

STANDARD LENGTH 10' 2"

26 GAUGE HI RIB

HI-RIB J Channel

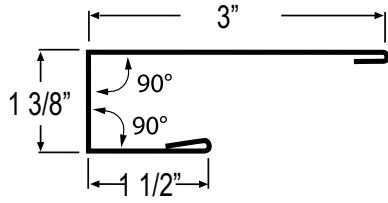

STANDARD LENGTH 10' & 12'

HI-RIB CORNER

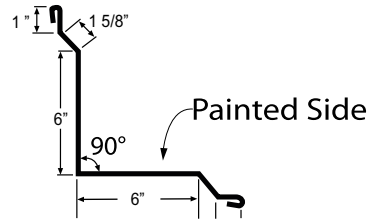

STANDARD LENGTH 10' 2"

HI-Rib Gambrel Flashing

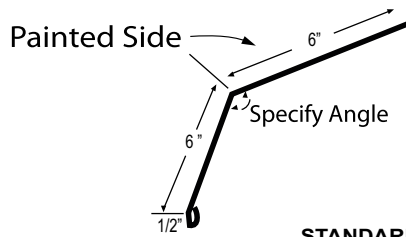

STANDARD LENGTH 10' 2"

HI-RIB Gable/Rake

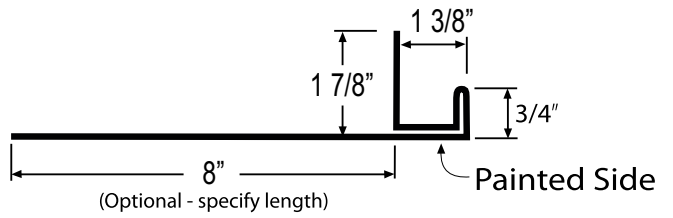

STANDARD LENGTH 10' 2"

HI-Rib Step Side Wall

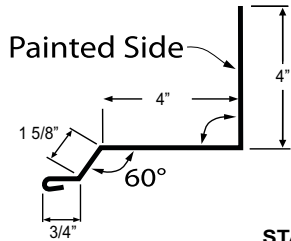

STANDARD LENGTH 10' 2"

HI-Rib Drip Edge

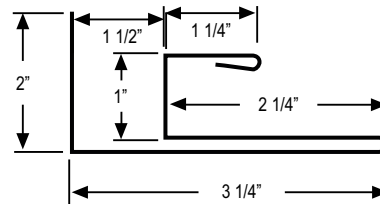

STANDARD LENGTH 10' 2"

Commercial Rake

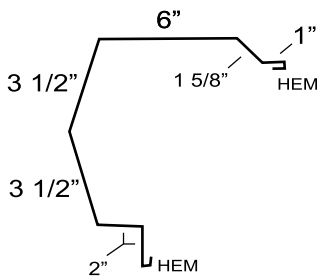

STANDARD LENGTH 10' 2"

Custom Bend Also Available

26 GAUGE HI RIB

Hang On Gutter

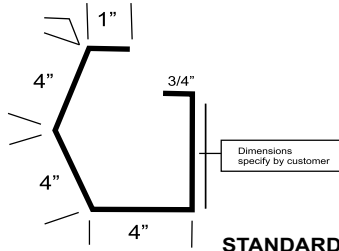

STANDARD LENGTH 10' 2"

Eave Gutter

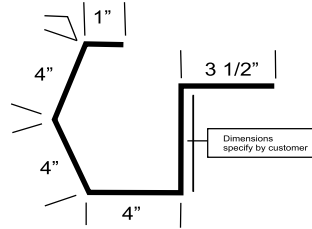

STANDARD LENGTH 10' 2"

HI-Rib Transition Flashing

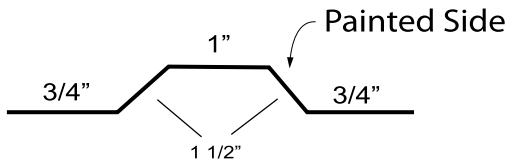

Field Prep

STANDARD LENGTH 10' 2"

HI-RIB Gable/Rake

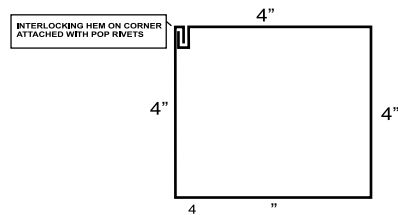

STANDARD LENGTH 10' 2"

Down Spout Strap

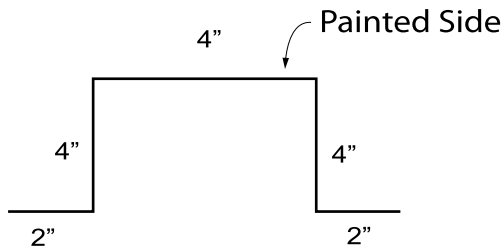

STANDARD LENGTH 10' 2"
Field Prep

Gutter End

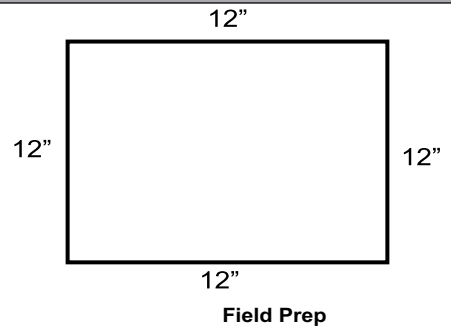

Field Prep

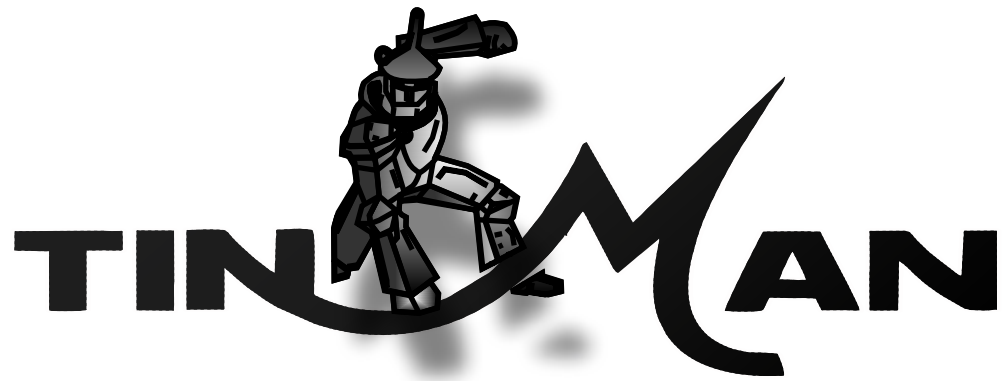

METALS

STANDING SEAM

TRIM

Tools and Materials Needed

Before starting the installation, gather all necessary tools and materials. This ensures a smooth workflow and reduces interruptions. Essential items include:

	<p>METAL ROOFING PANELS & TRIM PIECES</p>
	<p>SAFETY HARNESS AND LADDER</p>
	<p>UNDERLAYMENT</p>
	<p>PANCAKE SCREWS & CLIPS CLIPS ARE FOR S2000 PANEL</p>
	<p>ROOFING NAILS AND POP RIVETS</p>
	<p>METAL SNIPS OR A CUTTING TOOL</p>
	<p>MEASURING TAPE</p>
	<p>CAULKING GUN WITH METAL ROOFING SEALANT</p>
	<p>CORDLESS POWER DRILL & PHILLIPS BIT</p>
	<p>FOLDING TOOLS</p>

A1100 Metal Roof System

The A1100 metal roof panel is a 1 ¼" high standing seam metal roof system. This snap-lock architectural metal roof panel offers the designer an architectural solution by creating clean roof lines with a minimum of shadows and textures. With concealed clips and fasteners, it requires no mechanical seaming or separate seam cap.

Ideal for sloped roofs and exterior surfaces of light commercial and residential projects. The A1100 metal roofing panel is also available in a wide variety of coatings and colors.

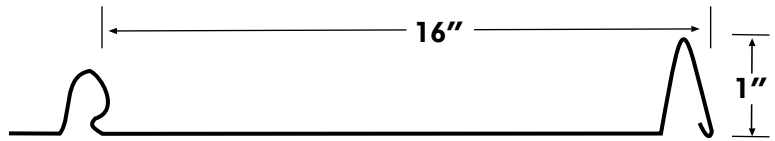
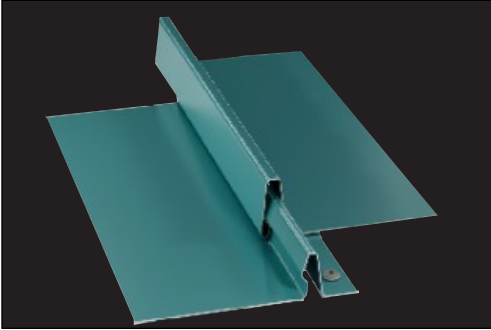

S2000 Metal Roof System

The S2000 metal roof panel is a 1 ¾" integral snap-lock metal roof system. Most popular metal roof system, this metal roof panel combines architectural versatility (for cleanly detailed, continuous seam transitions from roof to mansard, fascia, wall panel or soffit)

with the dramatically increased spanning and uplift capabilities of a structural metal roof system.

The S2000 structural metal roof panel is also available in a wide variety of coatings and colors.

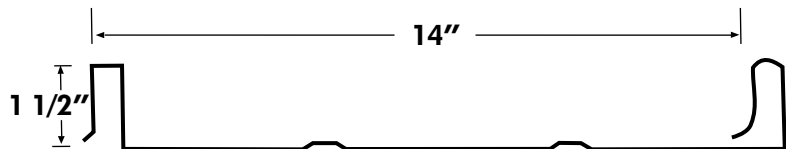
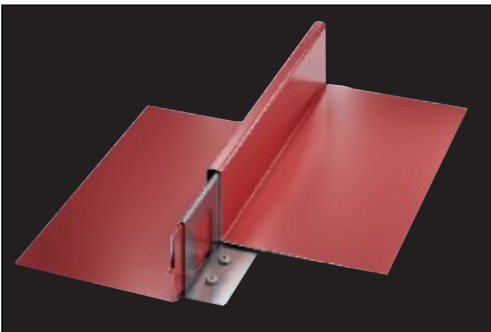

STANDING SEAM

Eave drip

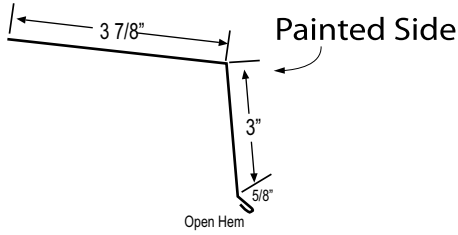

Requires Cleat & Offset Cleat

STANDARD LENGTH 10' 2"

Cleat

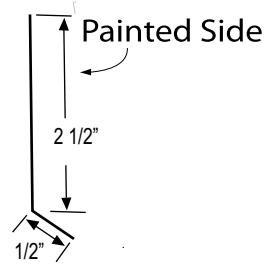

STANDARD LENGTH 10' 2"

Offset Cleat

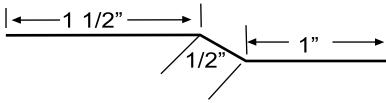

STANDARD LENGTH 10' 2"

Extended Eave

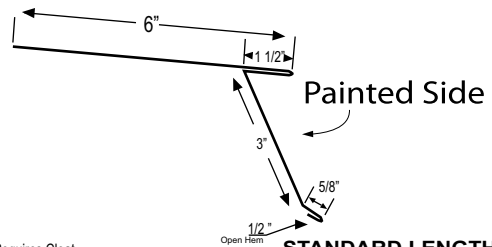

Requires Cleat

STANDARD LENGTH 10' 2"

Gable Rake

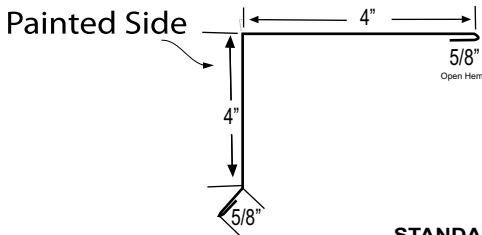

Requires Z Closure

STANDARD LENGTH 10' 2"

Mini Gable Rake

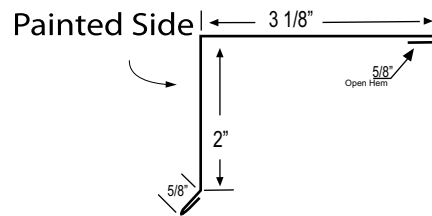

Requires Z Closure

STANDARD LENGTH 10' 2"

Step Rake

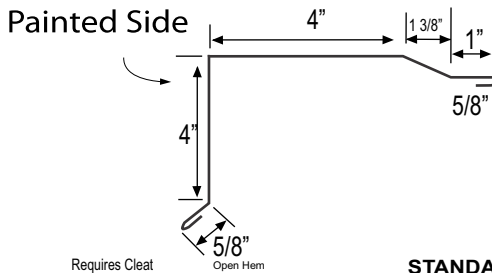

Requires Cleat

STANDARD LENGTH 10' 2"

Counter Flashing

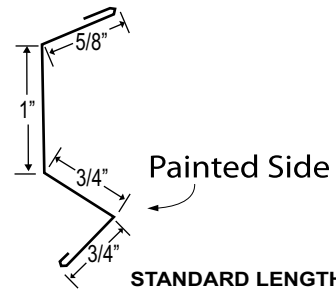

STANDARD LENGTH 10' 2"

Step Side Wall

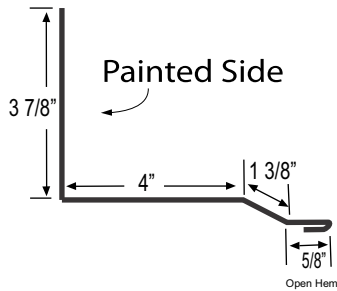

Requires Counter Flashing

STANDARD LENGTH 10' 2"

Side Wall

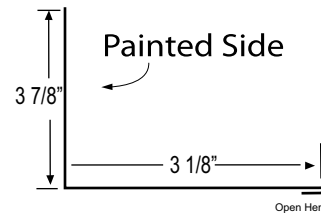

Requires Z Closure & Offset Cleat

STANDARD LENGTH 10' 2"

STANDING SEAM

Ridge Cap

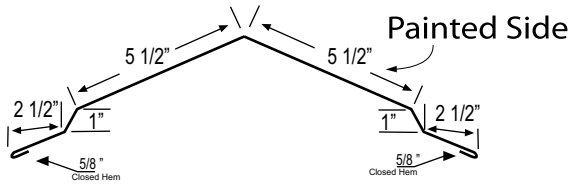

Requires Z Closure

STANDARD LENGTH 10' 2"

20" Ridge Cap

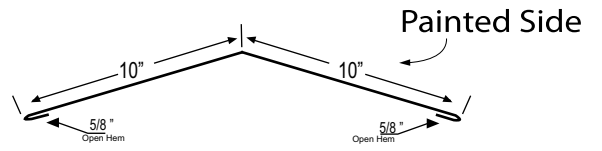

Requires Z Closure

STANDARD LENGTH 10' 2"

Hip Cap

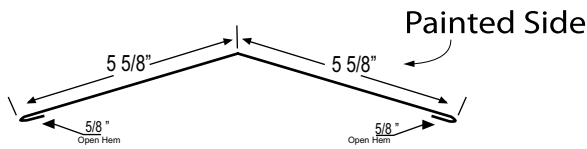

Requires Z Closure

STANDARD LENGTH 10' 2"

Z- Closure

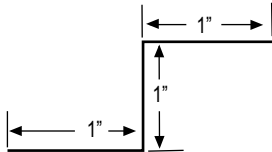

Requires Z Closure

STANDARD LENGTH 10' 2"

Peak Flashin

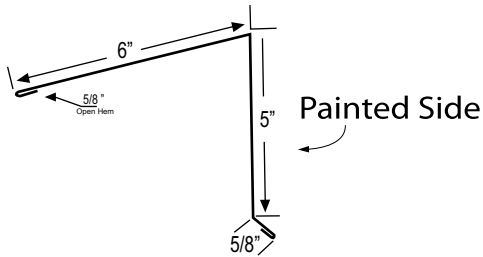

STANDARD LENGTH 10' 2"

Transition Flashin

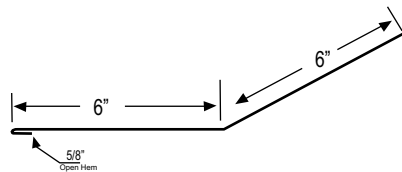

Requires Z Closure & Offset Cleat

Gambrel Flashing

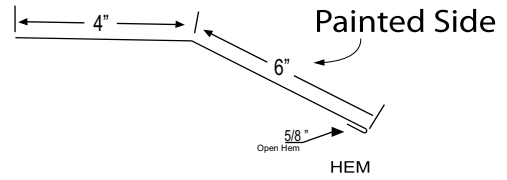

Requires Z Closure & Offset Cleat

STANDARD LENGTH 10' 2"

End Wall Flashing

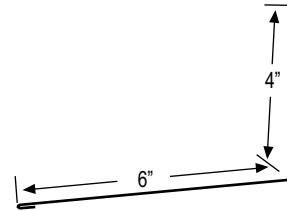

Requires Z Closure & Offset Cleat

STANDARD LENGTH 10' 2"

W- Valley

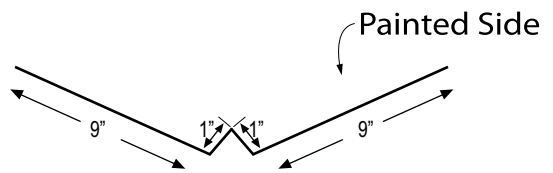

Requires Offset Cleat

STANDARD LENGTH 10' 2"

Reglet Flashing

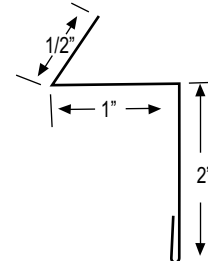

STANDARD LENGTH 10' 2"



TIN MAN

METALS

BOARD & BATTEN

TRIM

Board & Batten

Metal Batten siding seamlessly blends time-honored aesthetics with modern technology, offering the ultimate solution in exterior cladding. Crafted with a robust $\frac{3}{4}$ " x 2" metal batten, our metal siding replicates the authentic appearance of traditional wood board and batten siding. This durable metal board and batten siding offers longevity and eliminates the hassle of frequent painting, making it a low-maintenance option for the contemporary homeowner.

No Maintenance - No need to stain, paint, or seal

Limited 40 year paint warranty

Fire resistant

Termite and pest resistant





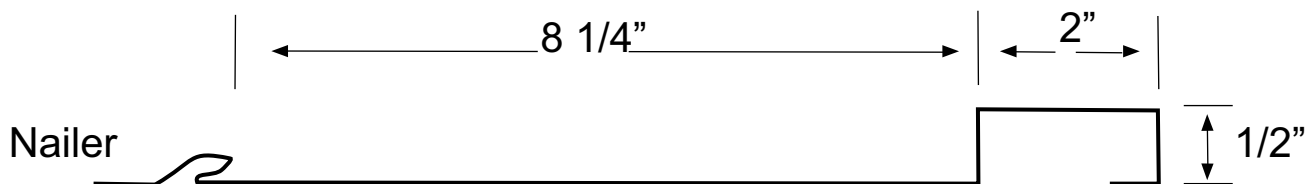

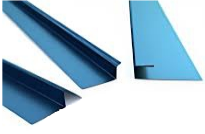

Cost about the same as wood

Wood Textured Panel



Tools and Materials Needed

Before starting the installation, gather all necessary tools and materials. This ensures a smooth workflow and reduces interruptions. Essential items include:

	METAL ROOFING PANELS & TRIM PIECES
	SAFETY HARNESS AND LADDER
	UNDERLAYMENT
	PANCAKE SCREWS & CLIPS CLIPS ARE FOR S2000 PANEL
	ROOFING NAILS AND POP RIVETS
	METAL SNIPS OR A CUTTING TOOL
	MEASURING TAPE
	CAULKING GUN WITH METAL ROOFING SEALANT
	CORDLESS POWER DRILL & PHILLIPS BIT

BOARD & BATTEN TRIM CATALOG

Jeff Channel

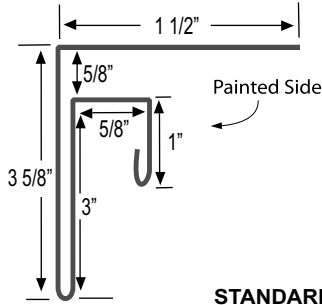

STANDARD LENGTH 10' 2"

Z Bar

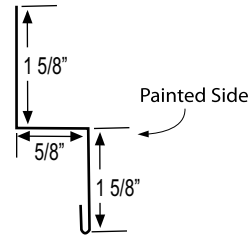

STANDARD LENGTH 10' 2"

Outside Corner

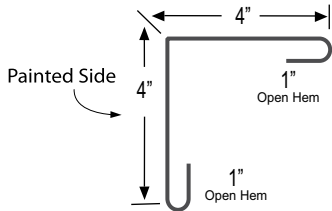

STANDARD LENGTH 10' 2"

Inside Corner

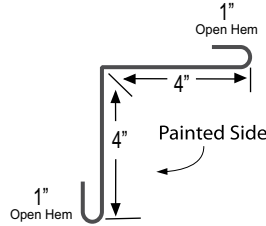

STANDARD LENGTH 10' 2"

Requires J - Metal or End Wall Flashing

Requires J - Metal or End Wall Flashing

J - Metal No Hem

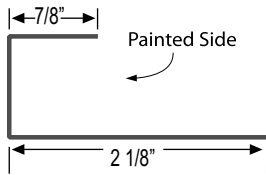

STANDARD LENGTH 10' 2"

End Wall Z Flashing No Hem

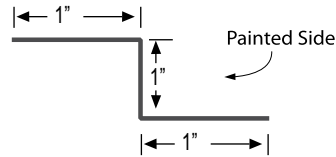

STANDARD LENGTH 10' 2"

J Channel Full Return

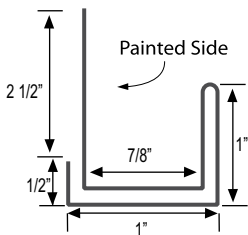

STANDARD LENGTH 10' 2"

Square Base

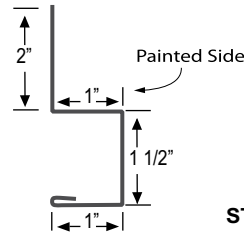

STANDARD LENGTH 10' 2"

Flat Base

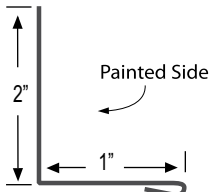

STANDARD LENGTH 10' 2"

Drip Flashing

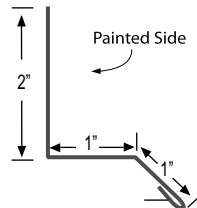

STANDARD LENGTH 10' 2"

Door Post Trim

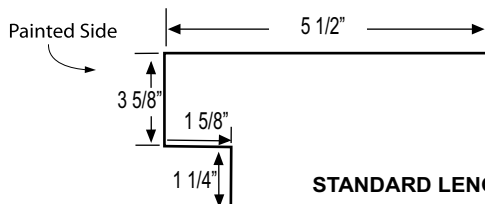

STANDARD LENGTH 10' 2"

3 1/2" Band Board

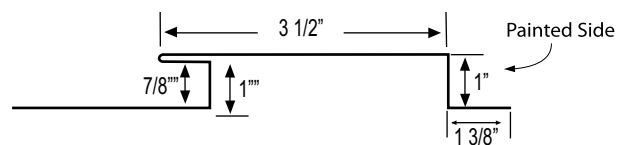

STANDARD LENGTH 10' 2"

BOARD & BATTEN TRIM CATALOG

J Channel

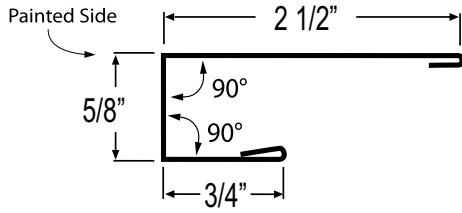

STANDARD LENGTH 10' 2"

Z Bar

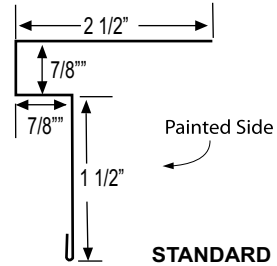

STANDARD LENGTH 10' 2"

5 1/2" Band Board

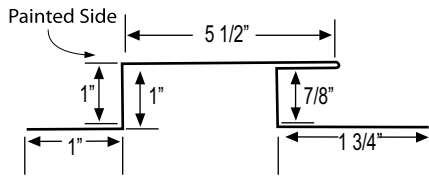

STANDARD LENGTH 10' 2"

Utility Trim

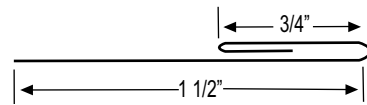

STANDARD LENGTH 10' 2"

Side And Bottom Window Trim

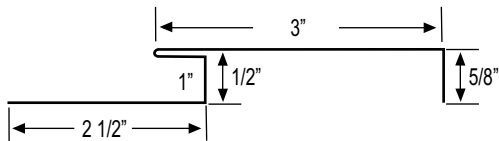

STANDARD LENGTH 10' 2"

Splice Trim

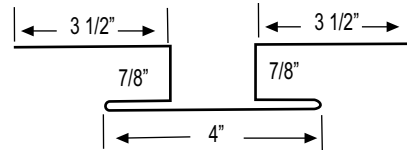

STANDARD LENGTH 10' 2"

Rat Guard

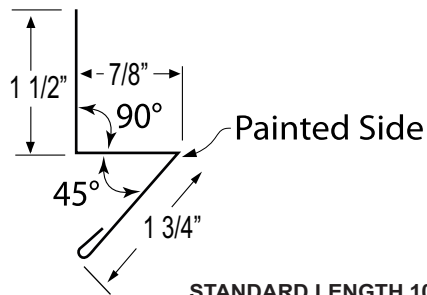

STANDARD LENGTH 10' 2"

Top Window Trim

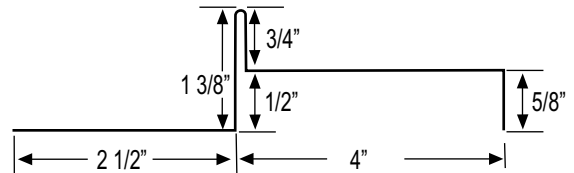

STANDARD LENGTH 10' 2"

B&B Outside Corner

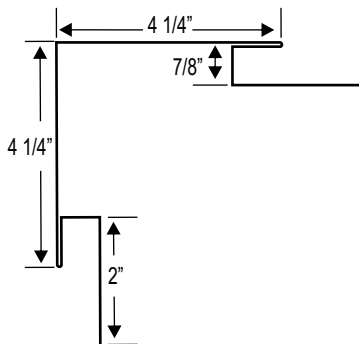

STANDARD LENGTH 10' 2"

B&B Inside Corner

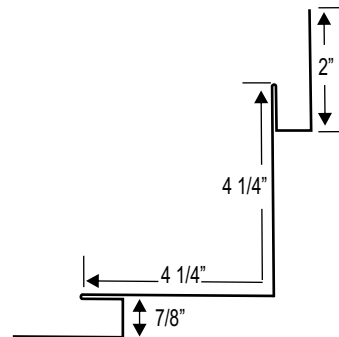

STANDARD LENGTH 10' 2"

HOW TO ORDER CUSTOM TRIM

DRAW THE TRIM AS ACCURATELY AS POSSIBLE

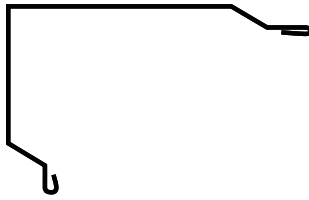

LABEL EACH AREA WITH THE DESIRED DIMENSIONS IN INCHES.

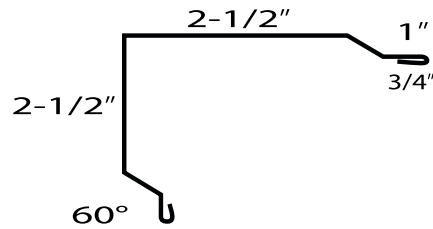

SPECIFY THE DESIRED ANGLES FOR THE TRIM

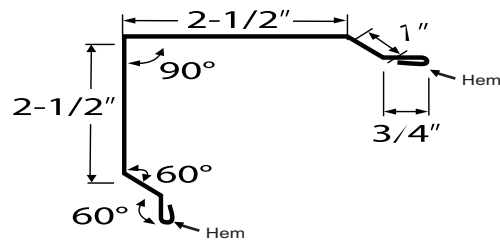

SPECIFY THE DESIRED PAINTED/FINISHED SIDE OF THE TRIM

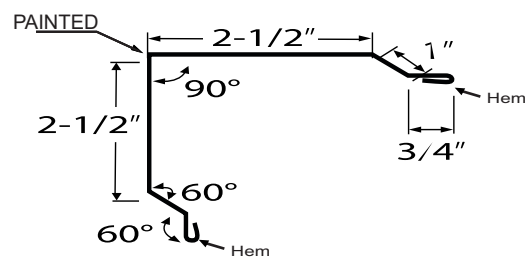

SPECIFY THE DESIRED QTY & COLOR OF THE TRIM

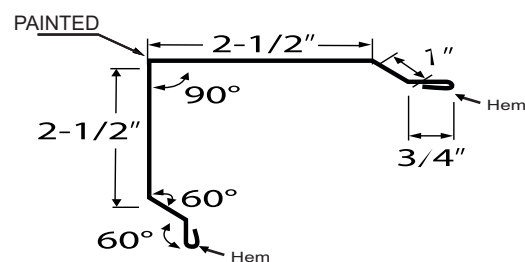

COLOR : CHARCOAL
QTY: 12

Cool Chemistry® - Coil Coating System



White

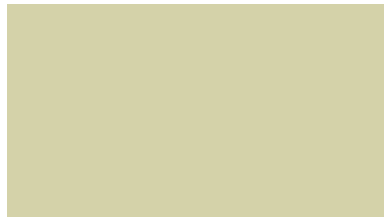

Lightstone



Red

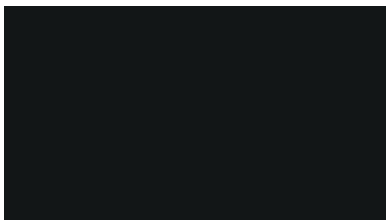

Black



Tan



★ Bright Red



Gray

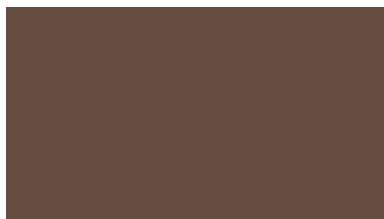

Brown



★ Dark Red



Charcoal



Forest Green



Blue



Burnished Slate

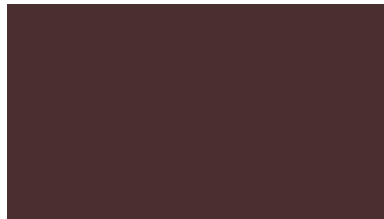

Burgundy



★ Gallery Blue

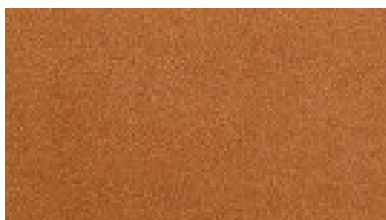

★ Copper Penny



Galvalume

*TSR = Total Solar Reflectance

*Actual colors may vary from samples shown. Actual color chips available upon request.

CERAM-A-STAR® 1050

STANDARD COLORS

G: Galvalume HDG: Hot Dip Galvanized

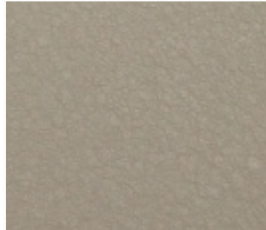

Light Stone WXD0080T



Coca Brown WXB1037T



Hawaiian Blue WXL0037T



Charcoal WXA0111T

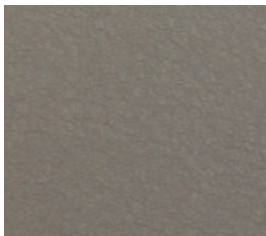

Ash Gray WXA0126T

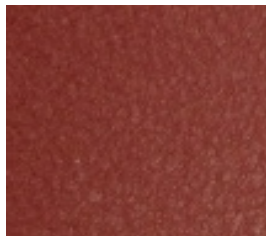

Rural Red WXR0085T

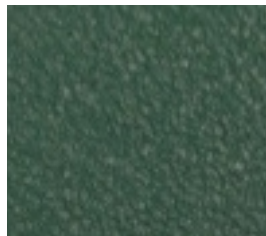

Evergreen WYG0034T

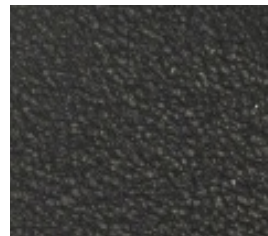

Black WXA0157T

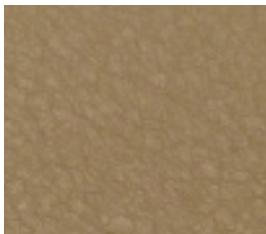

Timber Tan WXD0086T

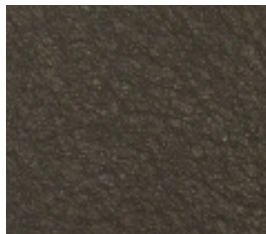

Burnished Slate WXB1017T

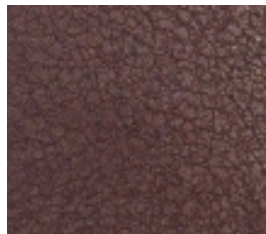

Burgundy WXR0099T

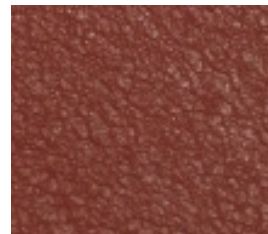

Rustic Red WXR0128T

PREMIUM COLORS



Silver Sage WYG0054T

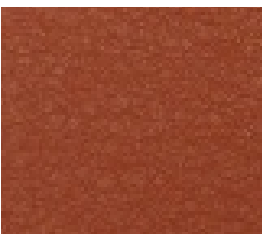

Rust WXR0105T



Gallery Blue WXL0048T

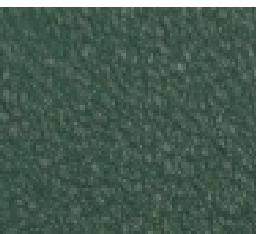

Forest Green WYG0048T

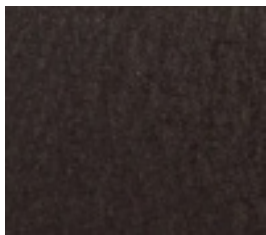

Dark Brown WXB1052T

The colors shown are for sample purposes only. This is a unique appearance coating that needs to be seen. Please request an actual color sample from our color experts.

WeatherXL



PREMIUM COLORS



Distressed Gray Barn wood



Gray Wash Barn wood



Black Burnt Wood

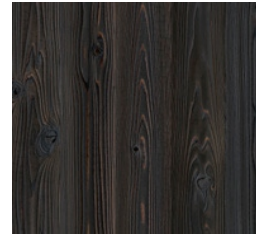

Charcoal Burnt Wood

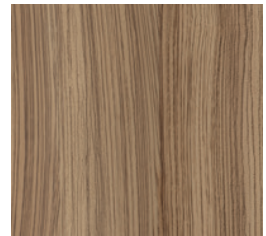

Zebrawood

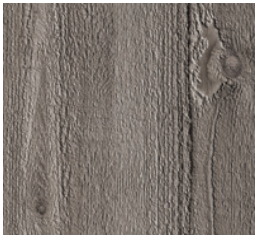

Rough Sawn Cedar Gray



Rough Sawn Cedar Distressed



Rough Sawn Cedar Taupe



Chippy White



Primitive Pine



Golden Oak



Gray Oak

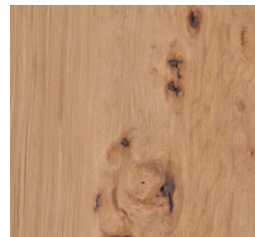

Hickory



Knotty Alder Plank



Dark Oak



Cedar



Rough Sawn Cedar



Rough Sawn Cedar Dark Brown



Rough Sawn Cedar Gray



Barn Wood Plank



Pecky Cypress



Walnut



Medium Oak



Realtree® Camouflage

Would You Believe It's Steel?

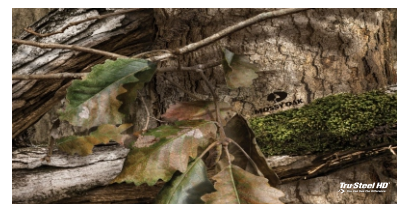

Mossy Oak® Camouflage



LOCATIONS:

67 TECH WAY STANFORD, KY

PH: (606) 365-7779

FX: (606) 365-7774

22504 Alberta St, Oneida, TN 37841

PH: (423) 569-2685

FX: (423) 569-2689

WWW.TinManMetals.com



Find us on

facebook